

STAINLESS STEEL SINK (SSS-2022)

- **REPAIRABLE FINISH:** Finish is scratch resistant to heavy-duty use. Deep scratches are repairable. Lustrous grain reflects light evenly for high shine.
- **DROP-IN INSTALLATION:** Sink is designed for drop-in installation to make the sink a focal point of your room.
- **18-GAUGE STAINLESS STEEL:** Highest quality 18-gauge thickness and Type 304 stainless steel for lasting durability, performance and lustrous beauty.
- **QUIET:** Sound-deadening pad(s) minimizes sound and vibration for a quieter time at the sink.
- **U-CHANNEL INSTALLATION:** Mounting clips placed inside the channel before installation mean less time under the sink for an easier install.
- **MADE IN THE USA**
- **DRAIN OPENING:** Sink drain opening measures 3 1/2".
- **CABINET SIZE:** Minimum cabinet size for this sink is 24".
- **FAUCET HOLES:** A single 1 1/2" faucet hole is standard. More holes are available on request.

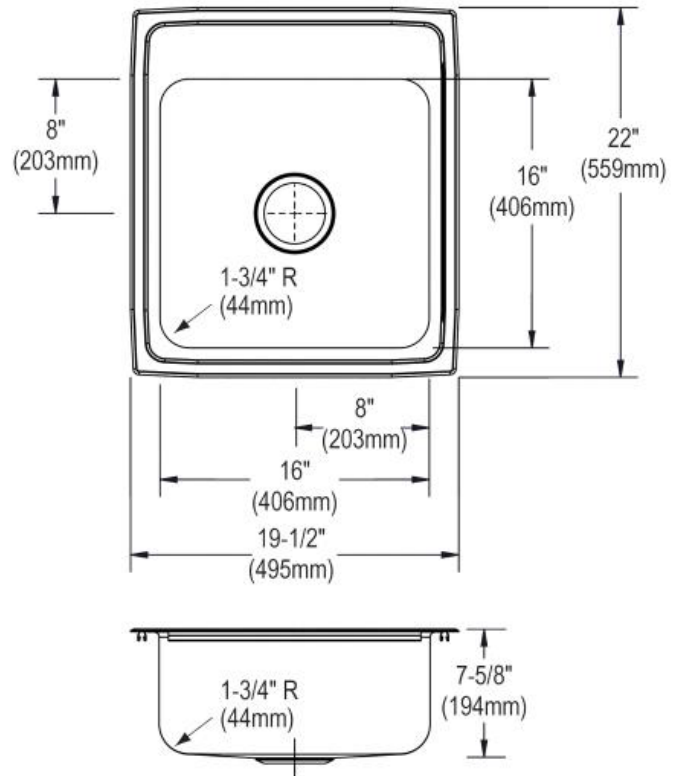

Installation Profile:

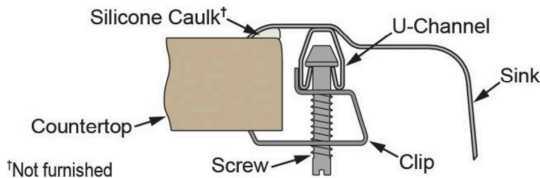

Cutout Dimensions for Drop-in Installation:

18 7/8" x 21 3/8" (479mm x 543mm) with 1 1/2" (38mm) corner radius