

EPOXY RESIN SINK (RS-45)

Dropln Sinks are top mounted. This simplified method of installation seals the sink cutout and eliminates the worksurface overhang between the inner walls of undermount sink basins and the sink cutout which can gather residual chemicals and bacteria.

All Dropln Sink surfaces are clearly visible and radiused for ease of cleaning.

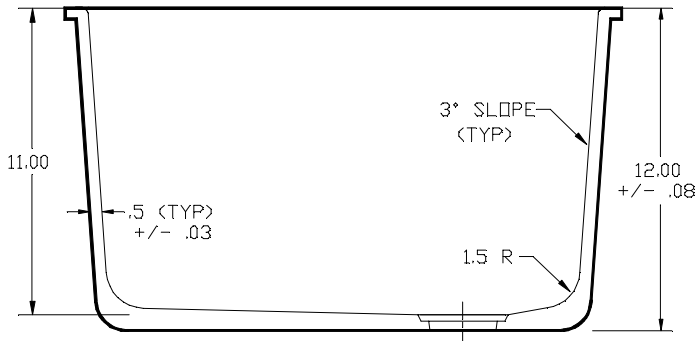

FRONT VIEW

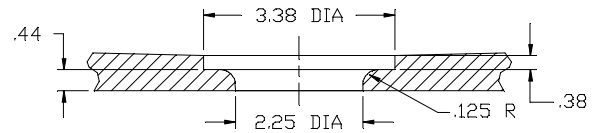

DRAIN OPENING DETAIL
SECTION A-A

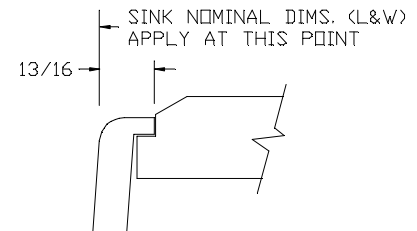

WALL DETAIL AT LIP

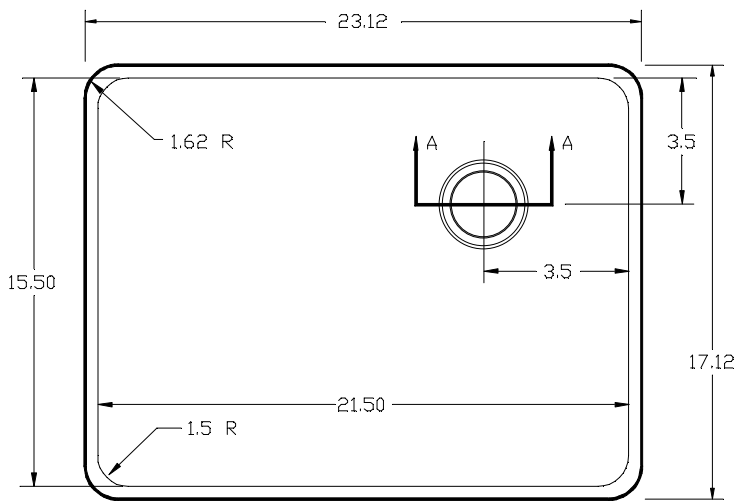

TOP VIEW

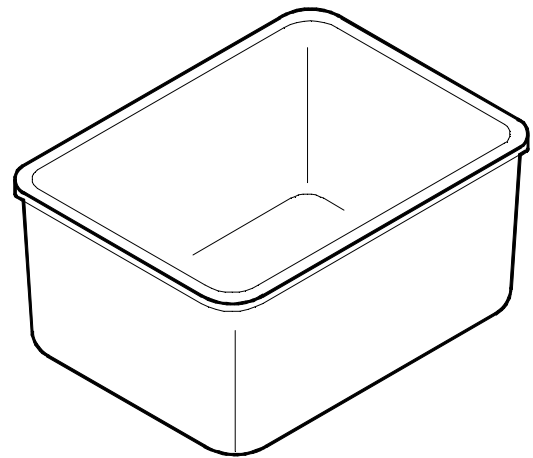

ISOMETRIC VIEW